

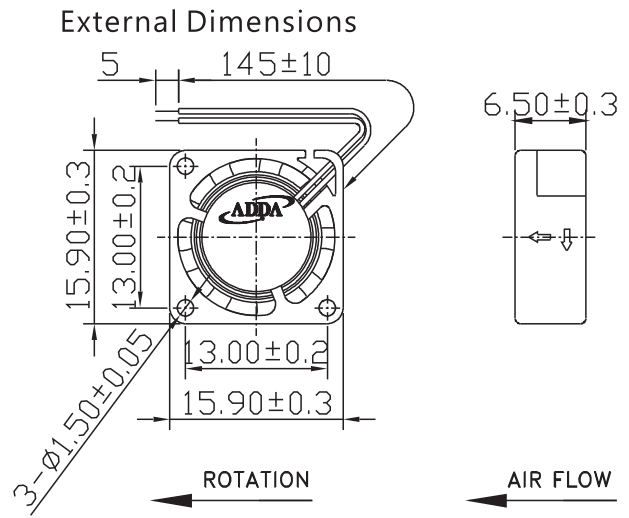

AD1506 SERIES

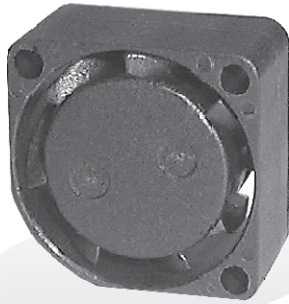

Frame:Plastic(UL:94V-0)
 Impeller:Plastic(UL:94V-0)
 Lead wire:UL1571AWG30

Specifications(Nominal)

*Noise is measured at the distance of one (1) meter from the axis of intake.

Frame size (mm)	Model No.	Bearing System Type	Rated Voltage (VDC)	Current (A)	Power (W)	Rated Speed (rpm)	Maximum AirFlow (CMM)	Maximum AirFlow (CFM)	Maximum Pressure (InAq)	Maximum Pressure (mmAq)	*Noise Level (dB/A)	Weight (g)
15x15x06	AD1505LX-K90(X)	●	5	0.035	0.175	9000	0.002	0.100	0.018	0.508	10.0	1.4
	AD1505MX-K90(X)	●	5	0.040	0.200	12000	0.004	0.160	0.030	0.762	12.0	
	AD1505HX-K90(X)	●	5	0.038	0.190	15000	0.005	0.200	0.065	1.727	24.3	

Specifications subject to change without notice.

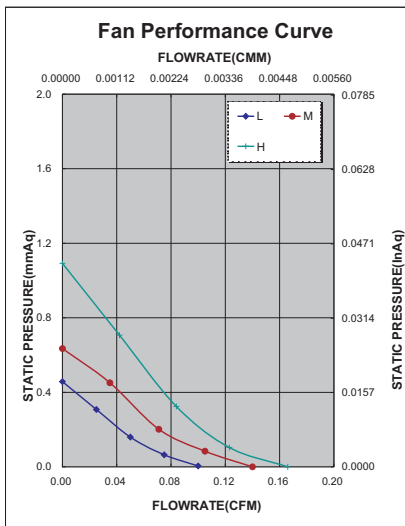

*Motor protective circuit and third lead wire functions

0	1	2	3	4	6	7	8	9	A	B
✓										

*Safety approvals

				✓