

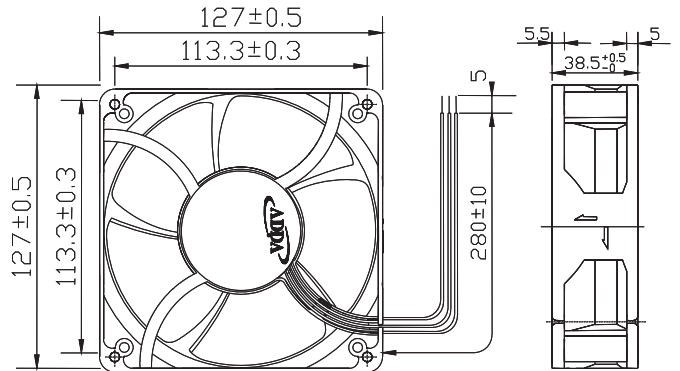

AG12738 SERIES

External Dimensions



Frame: Plastic(UL:94V-0)
 Impeller: Plastic(UL:94V-0)
 Lead wire: UL1007AWG24

Specifications(Nominal)

*Noise is measured at the distance of one (1) meter from the axis of intake.

Bearing type: ⊙=Ball ⊛=Sleeve ○=1B1S ●=Hypro bearing

Frame size (mm)	Model No.	Bearing System Type	Rated Voltage (VDC)	Current (A)	Power (W)	Rated Speed (rpm)	Maximum AirFlow (CMM)	Maximum AirFlow (CFM)	Maximum Pressure (InAq)	Maximum Pressure (mmAq)	*Noise Level (dB/A)	Weight (g)
127x127x38	AG12712LB385B00(0CU)	⊙	12	0.29	3.48	3000	3.016	106.574	0.493	12.522	46.0	360.0
	AG12712MB385B00(0CU)	⊙	12	0.63	7.56	4000	4.058	143.423	0.774	19.659	53.9	
	AG12712HB385B00(0CU)	⊙	12	0.83	9.96	4500	4.559	161.101	0.930	23.622	57.0	
	AG12712UB385B00(0CU)	⊙	12	1.16	13.92	5000	5.019	177.376	1.088	27.635	59.4	
	AG12724LB385B00(0CU)	⊙	24	0.15	3.60	3000	3.016	106.574	0.493	12.522	46.0	
	AG12724MB385B00(0CU)	⊙	24	0.30	7.20	4000	4.058	143.423	0.774	19.659	53.9	
	AG12724HB385B00(0CU)	⊙	24	0.43	10.32	4500	4.559	161.101	0.930	23.622	57.0	
	AG12724UB385B00(0CU)	⊙	24	0.55	13.20	5000	5.019	177.376	1.088	27.635	59.4	
	AG12724XB385B00(0CU)	⊙	24	0.73	17.52	5500	5.626	198.812	1.273	32.334	62.0	
	AG12748LB385B00(0CU)	⊙	48	0.09	4.32	3000	3.016	106.574	0.493	12.522	46.0	
	AG12748MB385B00(0CU)	⊙	48	0.17	8.16	4000	4.058	143.423	0.774	19.659	53.9	
	AG12748HB385B00(0CU)	⊙	48	0.23	11.04	4500	4.559	161.101	0.930	23.622	57.0	
	AG12748UB385B00(0CU)	⊙	48	0.29	13.92	5000	5.019	177.376	1.088	27.635	59.4	
	AG12748XB385B00(0CU)	⊙	48	0.38	18.24	5500	5.626	198.812	1.273	32.334	62.0	

Specifications subject to change without notice.

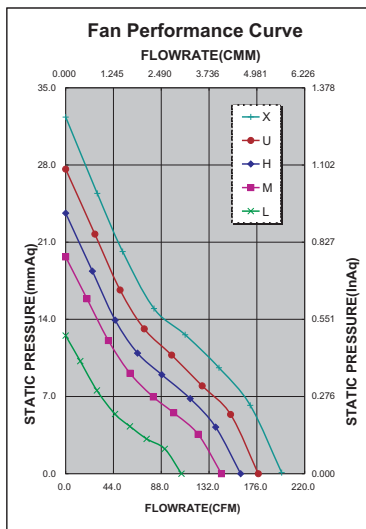

*Motor protective circuit and third lead wire functions

0	1	2	3	4	6	7	8	9	A	B
	✓	✓	✓					✓		✓

*Safety approvals

				✓