

EC Outer Rotor Fan SAA3P300-EC072 SERIES Ø300X94.5mm

- Impeller : Cold rolled steel
材質：冷軋鋼板
- Bearing System : Two Ball Bearing
軸承結構：滾珠軸承
- Protection Class : IP44
防護等級：IP44

DIMENSIONS DRAWING UNIT : mm

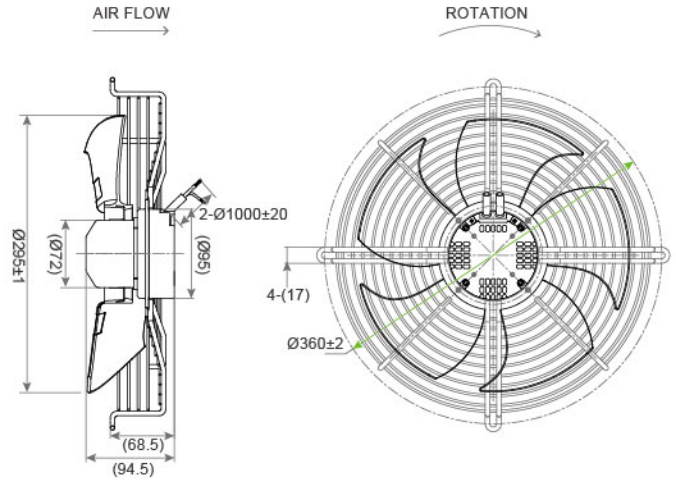
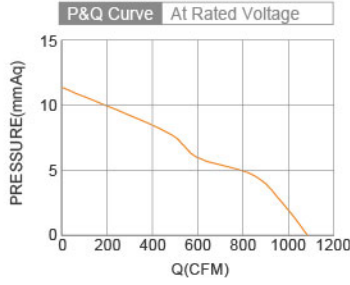

Model No.	Bearing Type	Voltage (VAC)	Frequency (Hz)	Current (A)	Power (W)	Speed (RPM)	Air Flow (CFM)	Air Flow (m³/min)	Air Pressure (mmH ₂ O)	Air Pressure (Inch H ₂ O)	Noise (dBA)
SAA3P300-EC072-A2	◎	220 (200~277)	50 / 60	0.4	60	1400	1087.8	30.90	11.83	0.47	63.0