

EC Outer Rotor Fan SAA3P550-EC137 SERIES Ø550X182mm

- Impeller : Cold rolled steel
材質：冷軋鋼板
- Bearing System : Two Ball Bearing
軸承結構：滾珠軸承
- Protection Class : IP44
防護等級：IP44

DIMENSIONS DRAWING UNIT : mm

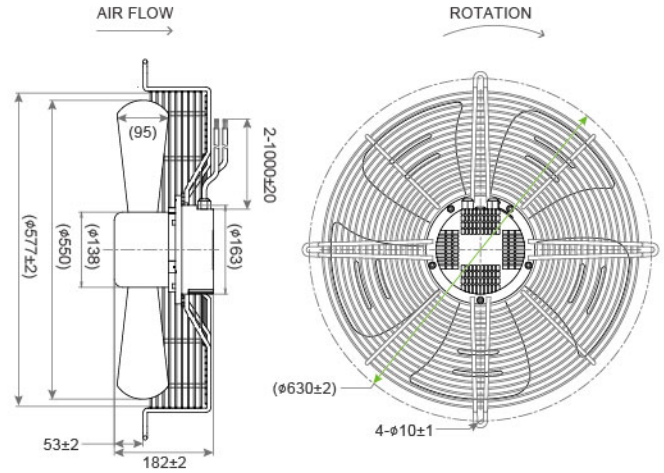
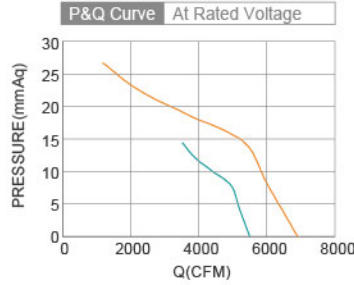

Model No.	Bearing Type	Voltage (VAC)	Frequency (Hz)	Current (A)	Power (W)	Speed (RPM)	Air Flow (CFM)	Air Flow (m³/min)	Air Pressure (mmH ₂ O)	Air Pressure (Inch H ₂ O)	Noise (dBA)
SAA3P550-EC137-A2	◎	220 (200~277)	50 / 60	2.6	550	1250	5409.6	153.64	14.28	0.56	71.0
SAA3P550-EC137-A3	◎	380 (380~480)	50 / 60	1.7	950	1690	6938.4	197.06	27.02	1.06	78.0